

EGX-MXM-T1000 (Preliminary)

Mobile PCI Express Module with NVIDIA® Quadro® Embedded T1000

Features

- NVIDIA® Quadro® T1000 embedded graphics
- Standard MXM 3.1 Type A (82 x 70 mm)
- 896 CUDA cores,
- 2.6 TFLOPS peak FP32 performance
- 4GB GDDR6 memory, 128-bit
- 192GB/s maximal memory bandwidth
- Support up to 4 DP 1.4a displays, 50W TGP
- 5-year availability

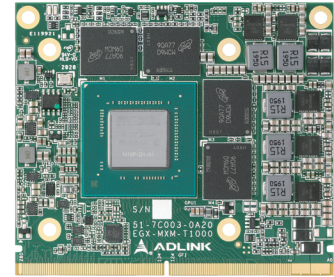
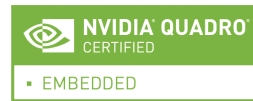

Introduction

The EGX-MXM-T1000 module features advanced NVIDIA® Turing™ GPU technology in MXM 3.1 Type A form factor. It's compact, slim and reliable design makes it suitable for mission critical environment. EGX-MXM-T1000 provides improved performance per watt. This MXM GPU module offers a flexible and easy solution for deep learning solutions for applications including medical, image processing, and gaming applications.

Ordering Information

- **EGX-MXM-T1000**
 NVIDIA® Quadro® T1000 Embedded Graphics, MXM 3.1 type A,
 82 x 70mm, PCIe x16 Gen3

Specifications

| Model Name | EGX-MXM-T1000 |
|--------------------------|--|
| Graphic Core | |
| GPU | Quadro® T1000 |
| Memory | 4GB GDDR6 memory, 128-bit, Bandwidth: 192 GB/s |
| GPGPU Computing | |
| CUDA Cores | 896 CUDA cores, 2.6 TFLOPS Peak FP32 performance |
| Compute API | CUDA Toolkit 8.0 and above, CUDA Compute version 6.1 and above, OpenCL™ 1.2 |
| Graphics API | DirectX® 12, OpenGL 4.6, Vulkan 1.0 API |
| Display | |
| Display Outputs | 4x DisplayPort 1.4a digital video outputs 4K at 120Hz or 8K at 60Hz |
| Interface | MXM 3.1, PCI Express Gen3 x16 support |
| Mechanicals | |
| Dimensions | 82 (W) x 70 (D) x 4.8 (H) mm |
| Form Factor | Standard MXM 3.1 Type A |
| Environmental | |
| Operating Temp. | Standard: 0°C to 55°C, ETT: -40°C to 85°C |
| Storage Temp. | -40°C to 85°C |
| Module Power Consumption | 50W TGP |
| SW Support | |
| OS Support | Windows 10 & Linux Drivers, 64-bit |

EGX-MXM-RTX3000 (Preliminary)

Mobile PCI Express Module with NVIDIA® Quadro® Embedded RTX3000

Features

- NVIDIA® Quadro® RTX3000 embedded graphics
- Standard MXM 3.1 Type B form factor (82 x 105 mm)
- 1920 CUDA cores, 30 RT cores, and 240 Tensor cores
- 5.3 TFLOPS peak FP32 performance
- 6GB GDDR6 memory, 192-bit
- 336GB/s maximal memory bandwidth
- Support up to 4 DP 1.4b displays, 80W TGP
- 5-year availability

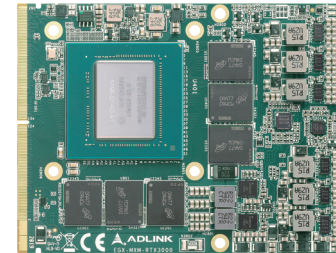
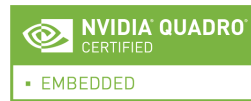

Introduction

The EGX-MXM-RTX3000 module features advanced NVIDIA® Turing™ GPU technology in MXM 3.1 Type B form factor. It's compact, slim and reliable design makes it suitable for mission critical environment. EGX-MXM-RTX3000 supports 4 DP1.4b displays offering a flexible and easy solution for medical and gaming applications.

Ordering Information

- **EGX-MXM-RTX3000**
 NVIDIA® Quadro® RTX3000 Embedded Graphics, MXM 3.1 type B, 82 x 105mm, PCIe x16 Gen3

Specifications

| Model Name | EGX-MXM-RTX3000 |
|--------------------------|--|
| Graphic Core | |
| GPU | Quadro® RTX3000 |
| Memory | 6GB GDDR6 memory, 192-bit, Bandwidth: 336 GB/s |
| GPGPU Computing | |
| CUDA Cores | 1920 CUDA® cores, 5.3 TFLOPS Peak FP32 performance |
| Tensor Cores | 240 Tensor Cores |
| Compute API | CUDA Toolkit 8.0 and above, CUDA Compute version 6.1 and above, OpenCL™ 1.2 |
| Graphics API | DirectX® 12, OpenGL 4.6, Vulkan 1.0 API |
| Display | |
| Display Outputs | 4x DisplayPort 1.4b digital video outputs 4K at 120Hz or 8K at 60Hz |
| Interface | MXM 3.1, PCI Express Gen3 x16 support |
| Mechanicals | |
| Dimensions | 82 (W) x 105 (D) x 4.8 (H) mm |
| Form Factor | Standard MXM 3.1 Type B |
| Environmental | |
| Operating Temp. | Standard: 0°C to 55°C, ETT: TBC |
| Storage Temp. | -40°C to 85°C |
| Module Power Consumption | 80W TGP |
| SW Support | |
| OS Support | Windows 10 & Linux Drivers, 64-bit |

EGX-MXM-RTX5000 (Preliminary)

Mobile PCI Express Module with NVIDIA® Quadro® Embedded RTX5000

Features

- NVIDIA® Quadro® RTX5000 embedded graphics
- Standard MXM 3.1 Type B+ form factor (82 x 110mm)
- 3072 CUDA cores, 48 RT cores, and 384 Tensor cores
- 9.4 TFLOPS peak FP32 performance
- 16GB GDDR6 memory, 256-bit
- 448GB/s maximal memory bandwidth
- Support up to 4 DP 1.4b displays, 110W TGP
- 5-year availability

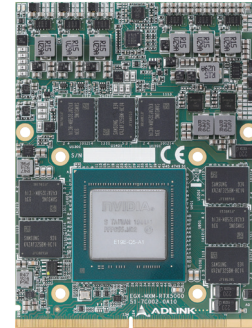

Introduction

The EGX-MXM-RTX5000 module features advanced NVIDIA® Turing™ GPU technology in MXM 3.1 Type B+ form factor. It's compact, slim and reliable design makes it suitable for mission critical environment. EGX-MXM-RTX5000 supports 4 DP 1.4b displays offering a flexible and easy solution for medical and gaming applications.

Ordering Information

- **EGX-MXM-RTX5000**
 NVIDIA® Quadro® RTX5000 Embedded Graphics, MXM 3.1 type B+, 82 x 110mm, PCIe x16 Gen3

Specifications

| Model Name | EGX-MXM-RTX5000 |
|--------------------------|--|
| Graphic Core | |
| GPU | Quadro® RTX5000 |
| Memory | 16GB GDDR6 memory, 256-bit, Bandwidth: 448 GB/s |
| GPGPU Computing | |
| CUDA Cores | 3072 CUDA® cores, 9.4 TFLOPS Peak FP32 performance |
| Tensor Cores | 384 Tensor Cores |
| Compute API | CUDA Toolkit 8.0 and above, CUDA Compute version 6.1 and above, OpenCL™ 1.2 |
| Graphics API | DirectX® 12, OpenGL 4.6, Vulkan 1.0 API |
| Display | |
| Display Outputs | 4x DisplayPort 1.4b digital video outputs 4K at 120Hz or 8K at 60Hz |
| Interface | MXM 3.1, PCI Express Gen3 x16 support |
| Mechanicals | |
| Dimensions | 82 (W) x 110 (D) x 4.8 (H) mm |
| Form Factor | Standard MXM 3.1 Type B+ |
| Environmental | |
| Operating Temp. | Standard: 0°C to 55°C, ETT: TBC |
| Storage Temp. | -40°C to 85°C |
| Module Power Consumption | 110W TGP |
| SW Support | |
| OS Support | Windows 10 & Linux Drivers, 64-bit |

EGX-MXM-P1000

Mobile PCI Express Module with NVIDIA® Quadro® Embedded P1000

Features

- Standard MXM 3.1 Type A form factor (82 x 70 mm)
- 512 NVIDIA® CUDA® cores
- 1.8 TFLOPS SP peak performance
- 4GB GDDR5 memory, 128-bit
- 96GB/s maximum memory bandwidth
- Support up to 4 UHD displays, 48W TDP
- 5-year availability

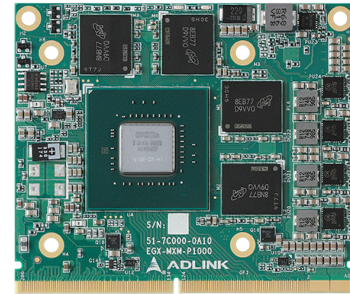

Introduction

The EGX-MXM-P1000 features advanced NVIDIA Quadro GPU with NVIDIA Pascal™ Architecture technology in MXM 3.1 Type A form factor. The EGX-MXM-P1000 has 512 NVIDIA CUDA cores and a peak single-precision floating-point performance of 1.8 TFLOPS. The EGX-MXM-P1000 has 4GB of GDDR5 memory and supports NVIDIA GPUDirect™ RDMA which helps increase data throughput by up to 80% and consequently system responsiveness by up to 60%*. Additionally, 4 UHD display outputs and an extended operating temperature range of -40°C to 85°C are supported. The embedded graphics product is suitable for mission-critical harsh-environment edge computing applications with size, weight, and power (SWaP) and network connectivity constraints.

Ordering Information

- **EGX-MXM-P1000**
NVIDIA Quadro Embedded P1000, MXM 3.1 type A, 82 x 70mm, PCIe x16 Gen3

Specifications

| | EGX-MXM-P1000 |
|--------------------------|--|
| Graphic Core | |
| GPU | Quadro® P1000 |
| Memory | 4GB GDDR5 memory, 128-bit, Bandwidth: 96 GB/s |
| GPGPU Computing | |
| CUDA Cores | 512 CUDA® cores, 1.8 TFLOPS SP Peak CUDA Toolkit 8.0, |
| Compute API | CUDA Compute version 6.1, OpenCL™ 1.2 |
| Graphics API | DirectX® 12, OpenGL 4.5, Vulkan 1.0 |
| Display | |
| Display Outputs | 4x DisplayPort 1.4 digital video outputs (DP++) 4K at 120Hz or 5K at 60Hz |
| Interface | MXM 3.1, PCI Express Gen3 x16 support |
| Mechanicals | |
| Dimensions | 82 (W) x 70 (D) x 4.8 (H) mm |
| Form Factor | Standard MXM 3.1 Type A |
| Environmental | |
| Operating Temp. | Standard: 0°C to 55°C, -40°C to 85°C |
| Storage Temp. | -40°C to 85°C |
| Module Power Consumption | 48W |
| SW | |
| OS Support | Windows 10 & Linux drivers, 64-bit |

* The software and workloads used in performance tests were optimized for performance on ADLINK platforms. Performance tests are measured using specific computer systems, components, software, operations and functions. Any changes to these factors may cause the results to vary. Contact ADLINK for more complete information about performance and benchmark results.

Block Diagram

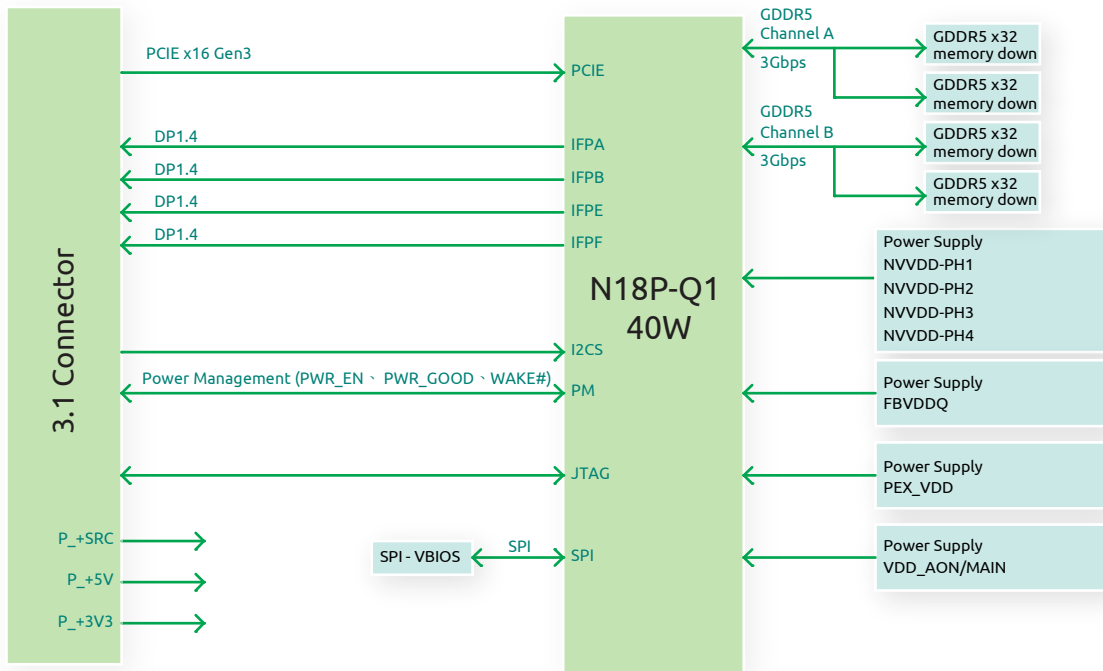

Mechanical Drawing

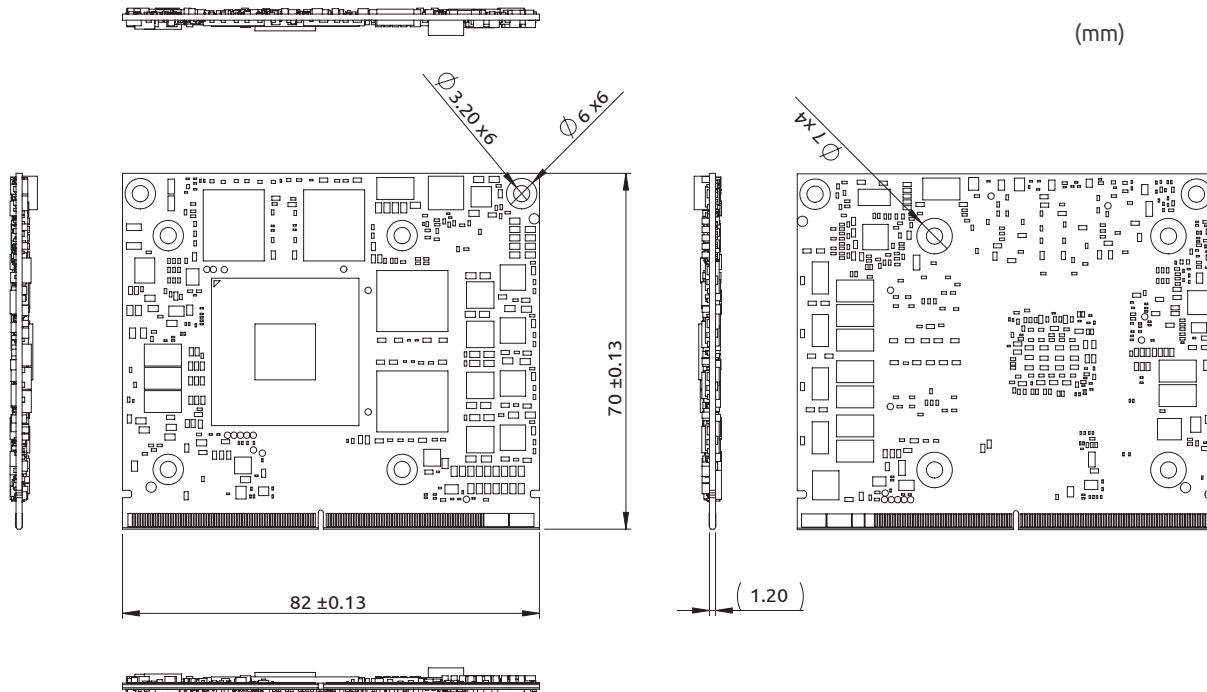

EGX-MXM-P2000

Mobile PCI Express Module with NVIDIA® Quadro® Embedded P2000

Features

- Standard MXM 3.1 Type A form factor (82 x 70 mm)
- 768 NVIDIA® CUDA® cores
- 2.3 TFLOPS SP peak performance
- 4GB GDDR5 memory, 128-bit
- 96GB/s maximum memory bandwidth
- Support up to 4 UHD displays, 58W TDP
- 5-year availability



Introduction

The EGX-MXM-P2000 features advanced NVIDIA Quadro GPU with NVIDIA Pascal™ Architecture technology in MXM 3.1 Type A form factor. The EGX-MXM-P2000 has 768 NVIDIA CUDA cores and a peak single-precision floating-point performance of 2.3 TFLOPS. The EGX-MXM-P2000 has 4GB of GDDR5 memory and supports NVIDIA GPUDirect™ RDMA which helps increase data throughput by up to 80% and consequently system responsiveness by up to 60%*. Additionally, 4 UHD display outputs and an extended operating temperature range of -40°C to 85°C are supported. The embedded graphics product is suitable for mission-critical harsh-environment edge computing applications with size, weight, and power (SWaP) and network connectivity constraints.

Ordering Information

- **EGX-MXM-P2000**
NVIDIA Quadro Embedded P2000, MXM 3.1 type A, 82 x 70mm, PCIe x16 Gen3

Specifications

| | EGX-MXM-P2000 |
|--------------------------|--|
| Graphic Core | |
| GPU | Quadro® P2000 |
| Memory | 4GB GDDR5 memory, 128-bit, Bandwidth: 96 GB/s |
| GPGPU Computing | |
| CUDA Cores | 768 CUDA® cores, 2.3 TFLOPS SP Peak |
| Compute API | CUDA Toolkit 8.0, CUDA Compute version 6.1, OpenCL™ 1.2 |
| Graphics API | DirectX® 12, OpenGL 4.5, Vulkan 1.0 |
| Display | |
| Display Outputs | 4x DisplayPort 1.4 digital video outputs (DP++) 4K at 120Hz or 5K at 60Hz |
| Interface | MXM 3.1, PCI Express Gen3 x16 support |
| Mechanicals | |
| Dimensions | 82 (W) x 70 (D) x 4.8 (H) mm |
| Form Factor | Standard MXM 3.1 Type A |
| Environmental | |
| Operating Temp. | Standard: 0°C to 55°C, -40°C to 85°C |
| Storage Temp. | -40°C to 85°C |
| Module Power Consumption | 58W |
| SW supports | |
| OS Support | Windows 10 & Linux drivers, 64-bit |

* The software and workloads used in performance tests were optimized for performance on ADLINK platforms. Performance tests are measured using specific computer systems, components, software, operations and functions. Any changes to these factors may cause the results to vary. Contact ADLINK for more complete information about performance and benchmark results.

Block Diagram

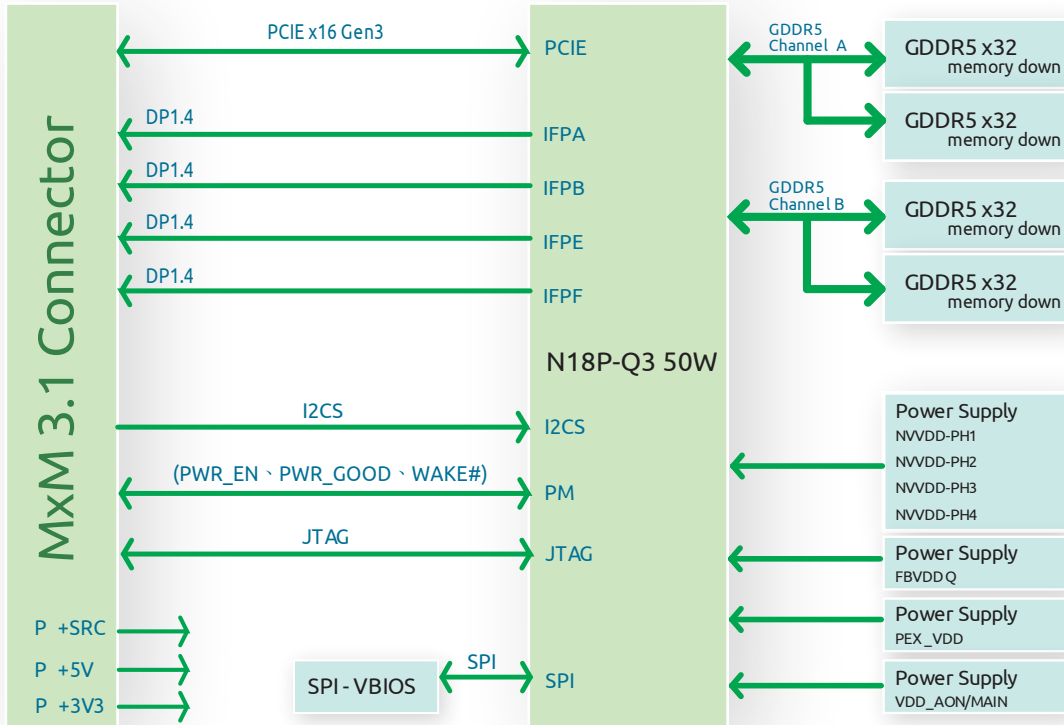

Mechanical Drawing

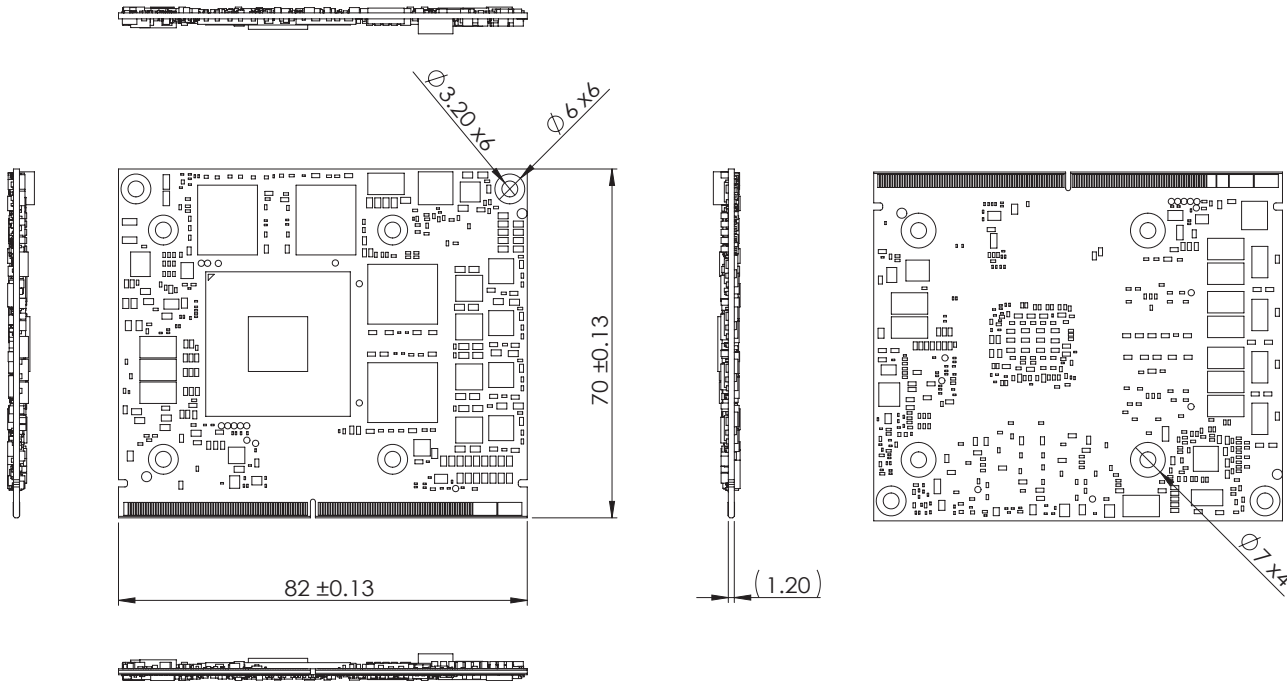

EGX-MXM-P3000

Mobile PCI Express Module with NVIDIA® Quadro® Embedded P3000

Features

- Standard MXM 3.1 Type B form factor (82mm x 105 mm)
- 1280 CUDA cores
- 3.9 TFLOPS peak FP32 performance
- 6GB GDDR5 memory, 192-bit
- 168GB/s peak memory bandwidth
- Maximum power 75W
- 5-year availability

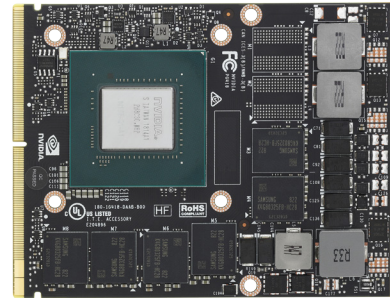

Introduction

Meeting the needs of embedded, ruggedized, and mobile system builders, the EGX-MXM-P3000 is specifically purposed to accommodate form factors incompatible with conventional PCI Express cards, and is built to maintain operations under a wide range of thermal and other environmental conditions. It's the ideal choice for blade-based and other deployments where high GPU density is critical, with a choice of GPU memory capacity, extremely reasonable power requirements, and flexible display options.

Ordering Information

- **EGX-MXM-P3000**
 NVIDIA® Quadro® Embedded P3000 , MXM 3.1 type B,
 82 x 105mm, PCIe x16 Gen3
 * The product is recommended to use with PIS-5500.

Specifications

| | EGX-MXM-P3000 |
|--------------------------|---|
| Graphic Core | |
| GPU | Quadro® P3000 |
| Memory | 6GB GDDR5 memory, 192-bit, Bandwidth: 168.2 GB/s |
| GPGPU Computing | |
| CUDA Cores | 1280 CUDA® cores, 3.9 TFLOPS peak FP32 Performance |
| Compute API | CUDA Toolkit 8.0, CUDA Compute version 6.1, OpenCL™ 1.2, Direct Compute |
| Graphics API | DirectX® 12, OpenGL 4.5, Vulkan 1.0 Shader Model 5.1 |
| Display | |
| Display Outputs | 4x DisplayPort 1.4 digital video outputs (DP++), 1x HDMI, 2x DVI, 1x eDP |
| Interface | MXM 3.1, PCI Express Gen3 x16 support |
| Mechanicals | |
| Dimensions | 82 (W) x 105 (D) x 4.8 (H) mm |
| Form Factor | Standard MXM 3.1 Type B |
| Environmental | |
| Operating Temp. | 0°C to 55°C |
| Storage Temp. | -40°C to 125°C |
| Module Power Consumption | 75W |
| SW Support | |
| OS Support | Windows 10 & Linux drivers, 64-bit |

EGX-MXM-P5000

Mobile PCI Express Module with NVIDIA® Quadro® Embedded P5000

Features

- Standard MXM 3.1 Type B form factor (82mm x 105 mm)
- 2048 CUDA cores
- 6.4 TFLOPS peak FP32 performance
- 16GB GDDR5 memory, 256-bit
- 192GB/s peak memory bandwidth
- Maximum power 100W
- 5-year availability

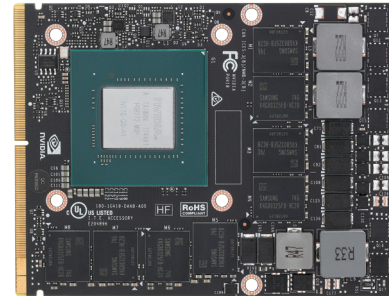

Introduction

Meeting the needs of embedded, ruggedized, and mobile system builders, the EGX-MXM-P5000 utilizes Quadro Pascal architecture to deliver superior graphics and computing performance. The EGX-MXM-P5000 is specifically purposed to accommodate form factors incompatible with conventional PCI Express cards, and is built to maintain operations under a wide range of thermal and other environmental conditions. It's the ideal choice for blade-based and other deployments where high GPU density is critical, with a choice of GPU memory capacity, extremely reasonable power requirements, and flexible display options.

Ordering Information

- **EGX-MXM-P5000**
 NVIDIA® Quadro® Embedded P5000, MXM 3.1 type B, 82 x 105mm, PCIe x16 Gen3

Specifications

| | EGX-MXM-P5000 |
|--------------------------|---|
| Graphic Core | |
| GPU | Quadro® P5000 |
| Memory | 16GB GDDR5 memory, 256-bit, Bandwidth: 192.2 GB/s |
| GPGPU Computing | |
| CUDA Cores | 2048 CUDA® cores, 6.4 TFLOPS peak FP32 performance |
| Compute API | CUDA Toolkit 8.0, CUDA Compute version 6.1, OpenCL™ 1.2, Direct Compute |
| Graphics API | DirectX® 12, OpenGL 4.5, Vulkan 1.0 Shader Model 5.1 |
| Display | |
| Display Outputs | 4x DisplayPort 1.4 digital video outputs (DP++), 1x HDMI, 2x DVI, 1x eDP |
| Interface | MXM 3.1, PCI Express Gen3 x16 support |
| Mechanicals | |
| Dimensions | 82 (W) x 105 (D) x 4.8 (H) mm |
| Form Factor | Standard MXM 3.1 Type B |
| Environmental | |
| Operating Temp. | 0 to 55 °C |
| Storage Temp. | -40 °C to 125 °C |
| Module Power Consumption | 100W |
| SW Support | |
| OS Support | Windows 10 & Linux drivers, 64-bit |